

1 2 3 4 5 6 7 8

A

A

B

B

C

C

D

D



E

E

F

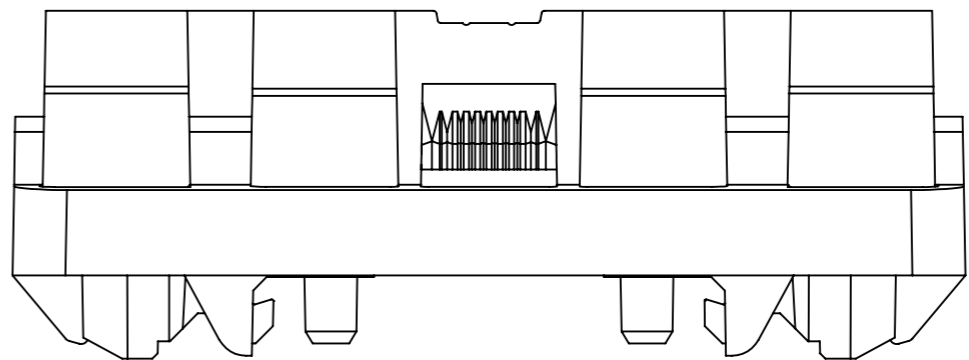
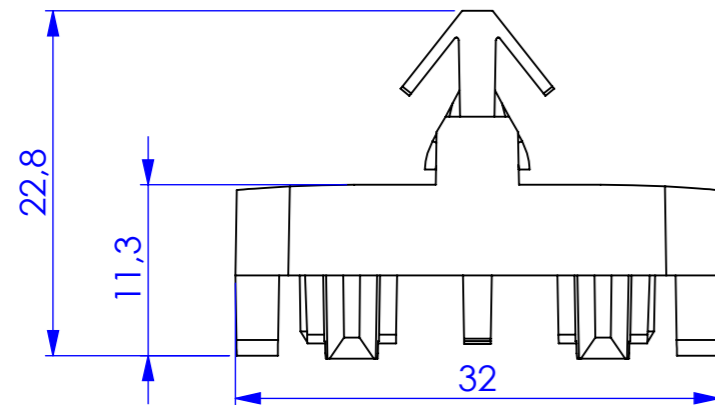
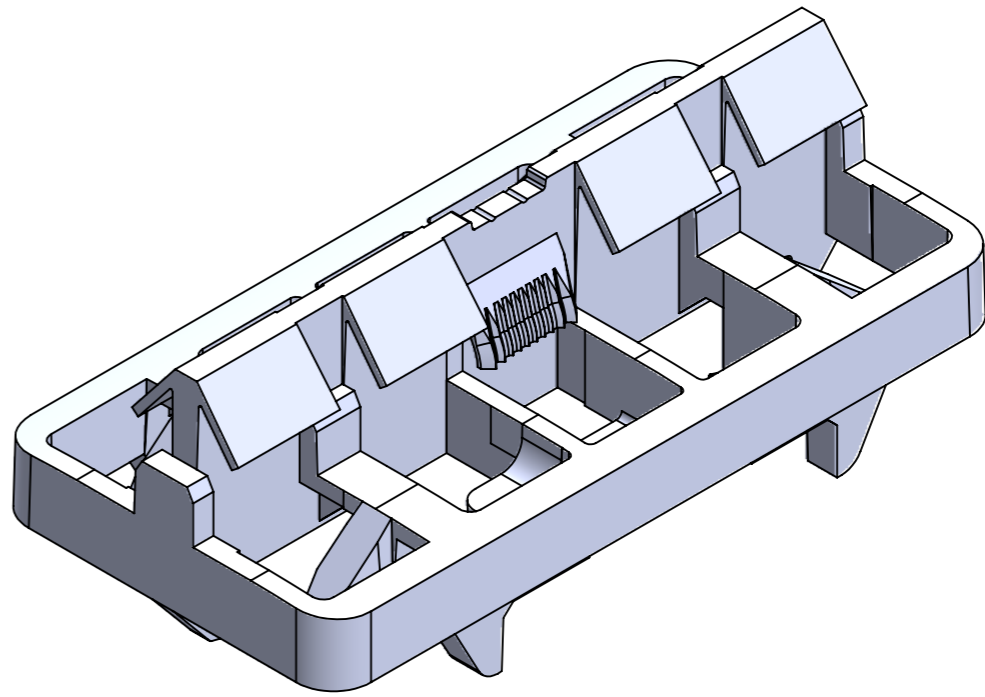
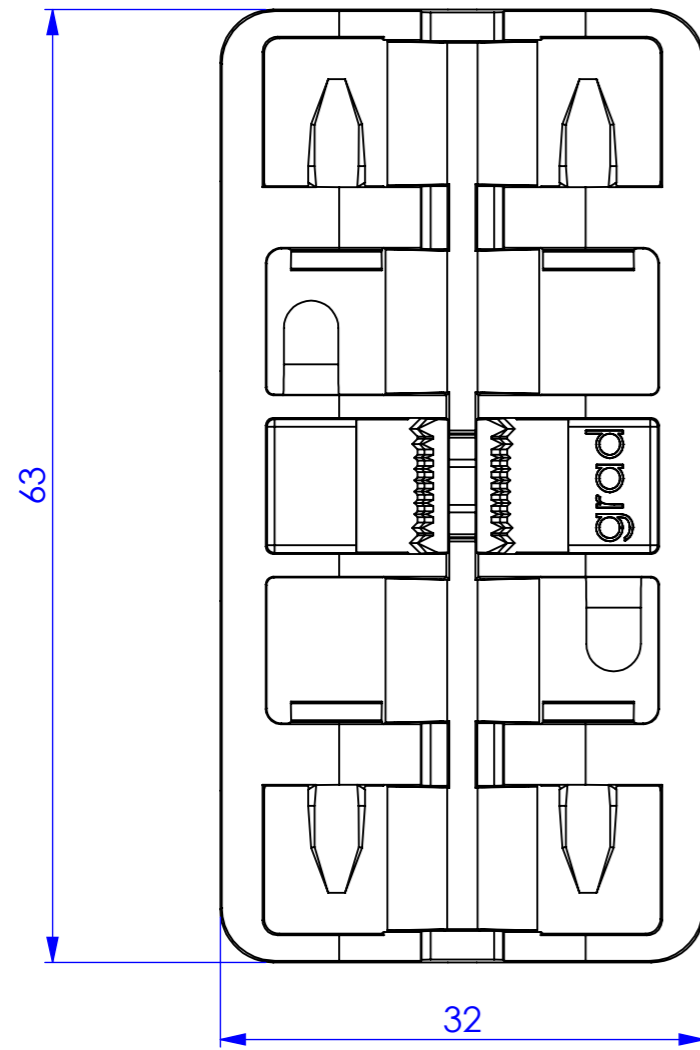
F

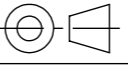

 	 Model		Treatment:		
	Project / Order no:		Date: 13-6-2024	Material:	
Drawing Title:		Designed by: Thijssen Engineering	Mass total:		
Drawing number: clip with lug		Revision:	Format: A3	Scale: 2:1	Sheet: 1/1

ANY UNAUTHORIZED USE, REPRODUCTION, DISTRIBUTION OR DISCLOSURE TO THIRD PARTIES IS STRICTLY FORBIDDEN. CLAD X RESERVES ALL RIGHTS REGARDING INTELLECTUAL PROPERTY RIGHTS

1 5 6 7 8